



X-TRAIL





## All-New Nissan X-Trail: fit in more family adventure

Introducing Nissan's latest family adventure crossover, powered by the spirited 2.5 petrol powertrain for invigorating performance & improved efficiency.

All-New Nissan X-Trail is a spacious crossover with up to seven seats\*, and everything you need to keep your family safe and comfortable with advanced Nissan's safety technologies.

With cutting-edge connectivity\* to keep everyone entertained, the All-New Nissan X-Trail shows that family-friendly trailblazing is possible.



\*Feature available depending on version, as standard or only as option (at an extra charge).

## Never compromise on style, in the All-New Nissan X-Trail

Get noticed wherever you go with sleek LED headlights, distinctive and imposing front air vents and robust, yet crafted lines. Up front, the unmistakable V-motion grille bears the familiar signature of Nissan's exciting design DNA, to show that this family crossover refuses to blend into the background.



Strong front fascia



Front Signature lamps



19" Alloy Wheels\*



Rear Signature lamps



\*Feature available depending on version, as standard or only as option (at an extra charge).



## Close the door on the chaos outside

Enjoy advanced Nissan Driver Assistance\* and HD navigation\* displayed right in your view as you settle into your comfortable, ergonomically designed seat. Wondering where to place your belongings? Don't miss the storage space beneath the floating central console. Inside the X-Trail's cabin, it's all about quality details – the relaxing atmosphere of ambient lighting\*, the soft feel of premium materials and the seamless convenience.



Ambient lighting\*



12.3" Fully digital meter\*  
10.8" Windscreen Head-up display\*



12.3" HD NissanConnect display\*

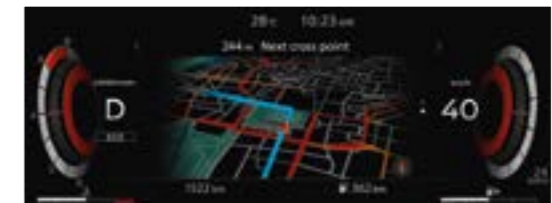

Navigation\*



Driving Aids\*

*\*Features available depending on version, as standard or only as option (at an extra charge).*

## Reinvent your all-wheel drive experience

Playgrounds are not meant to have boundaries. Take on new terrains in confidence with Nissan's unique all-wheel drive technology, now available on X-Trail. Nissan X-Trail delivers the perfect balance between powerful and unprecedented control, with a smooth ride for all family thanks to superior handling on any surface. Tailor your drive even further with 5 selectable Drive Modes, including Normal, Sport, Eco, Off-road and Snow Mode for unmatched levels of comfort.



4x4 Drive mode wheel switch\*



*\*Feature available depending on version, as standard or only as option (at an extra charge).*





## Safety First is Second Nature

The All-New Nissan X-Trail is equipped with advanced ProPILOT\* with Navi-link safety technologies designed to read the road ahead and adjust your drive accordingly, keeping you and your family safe for maximum peace of mind.

And thanks to Around View Monitor\*\*, all-round reassurance comes from a 360° view of your car with selectable focus on front, rear and kerbside views.

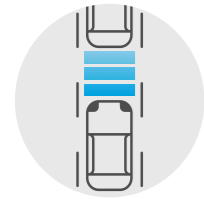

**INTELLIGENT CRUISE CONTROL** keeps your distance. It measures the distance from the vehicle ahead, controlling acceleration and deceleration to automatically maintain a suitable following distance within your set speed.

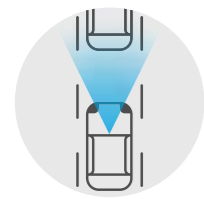

**PREDICTIVE COLLISION WARNING** keeps an eye up to two vehicles in front of you. When the system detects a sudden deceleration ahead, it gives you an audible and visual warning to slow down.



**EMERGENCY LANE KEEPING** A full suite of technologies to help you avoid unintentional lane departure. Keeps you centered in the lane either by steering wheel action or braking in an emergency situation.

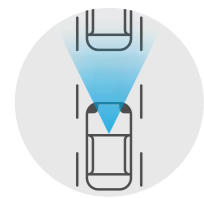

**FORWARD EMERGENCY BRAKE** Monitors the surrounding area in front of the car for vehicles and pedestrians, helping avoid or reduce damage caused by collisions.



## Seamlessly connected to your world

The 12.3" HD touchscreen<sup>(1)</sup> in the New Nissan X-Trail is your portal to NissanConnect: through intuitive navigation, advanced technology and more. Our smartphone App offers a growing range of services including sending journey plans to your new Nissan X-Trail. When inside your car, connect your phone to start using your preferred Apps thanks to Apple CarPlay<sup>®(2)</sup> and Android Auto<sup>™(2)</sup>. And wherever you are, it keeps you informed about the status of your car. You're all set for your adventures on the go.







## Family size matters for this family SUV

Forget the usual hassle of loading child seats. With rear doors that open to 85° and versatile seating layouts for up to 7\*, stress-free family adventures start the moment you leave. Whether in the front, 2nd or 3rd row seats, all passengers can feel relaxed with 3-Zone Air Conditioning\* and ergonomic seats for comfort on the longest journeys.



7 seats



5 seats



4 seats



2 seats

\*Feature available depending on version, as standard or only as option (at an extra charge).

## Discover the details that make a difference

Family adventures feel so comfortable with design details that make your journeys smoother. USB ports\* in the front and 2nd row to keep everyone's devices fully charged. When it comes to loading, enjoy up to 16 configurations with adaptable luggage boards\* and 60:40 sliding 2<sup>nd</sup> row to personalise your load space even further and ensure easy access to 3<sup>rd</sup> row.

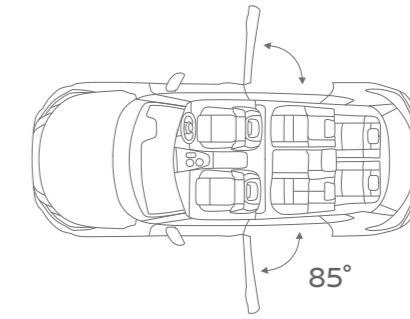

85° rear door opening



Floating centre console



Butterfly opening central console



Isifix fixing\*



USB ports in the 2<sup>nd</sup> row\*



3-zone air conditioning\*



\*Feature available depending on version, as standard or only as option (at an extra charge).

# ALL NEW NISSAN X-TRAIL SPECIFICATIONS

Model		2.5 Visia CVT	2.5 Acenta CVT	2.5 Acenta Plus CVT
Body type		5 Door Hatch	5 Door Hatch	5 Door Hatch
Transmission		CVT	CVT	CVT
Seating capacity		5	5	7
<b>ENGINE &amp; PERFORMANCE</b>				
Number of cylinders		4, in line	4, in line	4, in line
Maximum power	kW	135@6000	135@6000	135@6000
Maximum torque	Nm	244@3600	244@3600	244@3600
Engine displacement	cc	2488	2488	2488
Fuel type		Unleaded petrol	Unleaded petrol	Unleaded petrol
Fuel tank capacity	ℓ	55	55	55
Combined fuel consumption	ℓ/100 km	7,4	7,4	7,8
Top speed	km/h	195	195	195
Drag Coefficient	cd	0.33	0.33	0.33
Acceleration 0-100km	sec	10,4	10,4	10,4
CO2 Emissions Level	g/km	174	174	183
<b>SUSPENSION</b>				
Front		Independent strut	Independent strut	Independent strut
Rear		Multi-link	Multi-link	Multi-link
<b>DIMENSIONS &amp; WEIGHTS</b>				
Gross Vehicle Mass (GVM)	kg	2040	2040	2295
Overall length	mm	4680	4680	4680
Overall width	mm	1840	1840	1840
Overall height	mm	1725	1725	1725
Wheelbase	mm	2705	2705	2705
Track: Front	mm	1585	1585	1585
Track: Rear	mm	1590	1590	1590
Front overhang	mm	935	935	935
Rear overhang	mm	1040	1040	1040
Ground clearance	mm	211	211	211
Towing capacity - Unbraked	kg	750	750	750
Towing capacity - Braked	kg	2000	2000	2000
Min. turning circle	m	11,1	11,1	11,1
<b>WHEELS / TYRES</b>				
Wheel size/type		17" Alloy	18" Alloy	19" Alloy
Wheel dimensions		235/65 R17	235/60 R18	235/55 R19
Temporary spare wheel (Steel)		Standard	Standard	Standard
<b>EXTERIOR</b>				
Head lamp Type		LED	LED	LED
High Beam Assist		Standard	Standard	Standard
Auto wipers & lights		-	-	Standard
Follow Me Home		Standard	Standard	Standard
LED Daytime running lights		Standard	Standard	Standard
Front LED fog lights		-	Standard	Standard
Roof rails		Standard	Standard	Standard

Model		2.5 Visia CVT	2.5 Acenta CVT	2.5 Acenta Plus CVT
Rear roof spoiler		Standard	Standard	Standard
2-Tone Color		-	Optional	Optional
Door mirror and handle finish		Body colour	Body colour	Body colour
Door mirror adjustment		Electrical Adjustment	Electrical Adjustment	Electrical Adjustment
Auto Folding Mirrors		Standard	Standard	Standard
Heated Mirrors		Standard	Standard	Standard
Front wipers		Wiper Arm (Washer Nozzle) with Variable Intermittent, Speed Sensitive	Wiper Arm (Washer Nozzle) with Variable Intermittent, Speed Sensitive	Wiper Arm (Washer Nozzle) with Variable Intermittent, Speed Sensitive
Rear window wiper		Standard	Standard	Standard
Rear Window Defogger		Standard	Standard	Standard
Limited slip differential		Standard	Standard	Standard
<b>DRIVER'S AREA</b>				
A-IVI 8" display		Standard	Standard	-
A-IVI 12.3" display		-	-	Standard
Full TFT Meter		-	-	Standard
Heads Up display		-	-	Standard
Steering wheel material		Urethane	Leather	Leather
Paddle Shift		Standard	Standard	Standard
Low fuel warning light		Standard	Standard	Standard
Clock		Standard	Standard	Standard
Outside temperature gauge		Standard	Standard	Standard
<b>COMFORT &amp; CONVENIENCE</b>				
Seat upholstery		Cloth	Synthetic leather	Synthetic leather
Front Heated Seats		-	Standard	Standard
Sun Visor with Mirror and light incl. Driver & Passenger Card Holder		Standard	Standard	Standard
Drive Mode Selector		Standard	Standard	Standard & Terrain mode
Economic Driving		Standard	Standard	Standard
Rear seat split		*60:40 seat split, Manual Reclining & Single folding"	40:20:40 split, Manual slide & manual reclining, single folding & armrest through	W/ 50:50 split, Manual Reclining & Dive down folding
Central locking + child lock		Standard	Standard	Standard
Remote key - touch sensor door handle		Standard	Standard	Standard
Push Start Button		Standard	Standard	Standard
Electric windows		Front & rear, one touch up/down incl. Auto Reverse	Front & rear, one touch up/down incl. Auto Reverse	Front & rear, one touch up/down incl. Auto Reverse
Rear view mirror		Manual dimming	Electro-chromatic anti-dazzle rear view mirror	Electro-chromatic anti-dazzle rear view mirror
Tilt & telescopic steering wheel		Standard	Standard	Standard
Seat Adjustment		Driver Manual slide, recline & lift seats, power lumbar 2way; Passenger Manual slide & recline	Driver power slide, recline, lift, tilt & 2 way lumbar seats; Passenger Manual slide & recline	Driver power slide, recline, lift, tilt & 2 way lumbar seats; Passenger Manual slide & recline
Intelligent Cruise Control		Standard	Standard	Standard
On Board Navigation system		-	-	Standard
Audio		8" Touch Screen/AM/FM radio/ USB*2 & DAB	8" Touch Screen/AM/FM radio/ USB*2 & DAB	A-IVI2 PH1 NAVI 12.3" touch screen/ AM/ FM radio, USB*2, I-KEY LINK & DAB

# ALL NEW NISSAN X-TRAIL SPECIFICATIONS

Model		2.5 Visia CVT	2.5 Acenta CVT	2.5 Acenta Plus CVT
No of speakers		6	6	6
Hands-free Bluetooth® system		Standard	Standard	Standard
Steering wheel controls		Hands-free Bluetooth, telephone, audio, Intelligent cruise control	Hands-free Bluetooth, telephone, audio, Intelligent cruise control	Hands-free Bluetooth, telephone, audio, Intelligent cruise control
Air-conditioner		Manual A/C	Dual Zone auto A/C	Dual Zone auto A/C
Sunglass Holder		Standard	Standard	Standard
Tonneau cover		Standard	Standard	Standard
Front centre armrest		Standard	Standard	Standard
Armrest + rear seat cup holder		Standard	Standard	Standard
Power outlet 12V		Standard	Standard	Standard
Center console cup holders		Standard	Standard	Standard
Cup holders		Standard	Standard	Standard
Fuel lid capless (push)		Standard	Standard	Standard
Luggage area lamp		Standard	Standard	Standard
Luggage capacity (Seats Up), litres	ℓ	585	585	485
Luggage capacity (Seats Down to waist line), litres	ℓ	742	742	651
Luggage capacity (Seats Down - to Roof), litres	ℓ	1396	1396	1298
<b>SAFETY AND SECURITY</b>				
Airbags		Driver, Passenger, Curtain, Front Side & Front far side airbags	Driver, Passenger, Curtain, Front Side & Front far side airbags	Driver, Passenger, Curtain, Front Side & Front far side airbags
DR + PAS + Rear Seat belt reminder		Standard	Standard	Standard
Anti-lock braking system (ABS)		Standard	Standard	Standard
Electronic brake-force distribution (EBD)		Standard	Standard	Standard
Brake Assist System (BAS)		Standard	Standard	Standard
Hill Start Assist (HSA)		Standard	Standard	Standard
Hill Descent Control		Standard	Standard	Standard
Vehicle Dynamic Control (VDC)		Standard	Standard	Standard
Tire Pressure Monitor		Standard	Standard	Standard
Around View Monitor + Moving Object Detection		-	-	Standard
Reverse Camera		Standard	Standard	Standard
Blind Spot Intervention		-	Standard	Standard
Cross Traffic Alert		-	Standard	Standard
Predictive Front Collision Warning		Standard	Standard	Standard
Forward Emergency Braking (City, Inter Urban +Pedestrian & Cyclist)		Standard	Standard	Standard
Lane Departure Warning incl. Lane Departure Prevention		Standard	Standard	Standard
ProPILOT		-	Standard	Standard
Lane Keep Assist (LKA)		Standard	Standard	Standard
Driver Attention Alert		Standard	Standard	Standard
Electric Parking Brake incl. Auto Hold		-	Standard	Standard

Model		2.5 Visia CVT	2.5 Acenta CVT	2.5 Acenta Plus CVT
Parking Sensors		Rear	Front & Rear	Front & Rear
ISOFIX		Standard	Standard	Standard
Privacy glass		-	Standard	Standard
Immobiliser		Standard	Standard	Standard
<b>SERVICE &amp; WARRANTY</b>				
Service Intervals		15 000 km	15 000 km	15 000 km
Service Plan		3 year / 90 000km	3 year / 90 000km	3 year / 90 000km
Mechanical Warranty		6 year / 150 000km	6 year / 150 000km	6 year / 150 000km

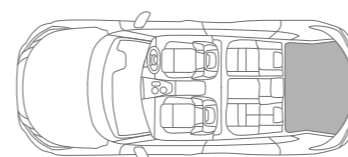

WITH 5 SEATS

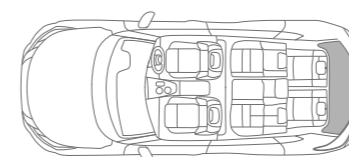

WITH 7 SEATS



A

B



C

D

**A:** Overall length:  
4680 mm

**B:** Wheelbase:  
2705 mm

**C:** Width:  
1840 mm w/o mirrors | 2065 mm with mirrors opened

**D:** Overall height:  
1725 mm

\*Feature available depending on version, as standard or only as option (at an extra charge).

## GRADES

### VISIA

- LED headlamp
- Rear parking sensors
- Manual A/C
- 17» alloy wheel
- 8» Display Audio
- High Beam Assist

### ACENTA

- Visia equipments
- + Front parking sensors
- + Around View Monitor with Moving Object Detection
- + 18» alloy wheels
- + Synthetic leather seats
- + Dual zone AT aircon
- + Tire pressure monitor
- + Lane Keeping Assist

### ACENTA PLUS

- Acenta equipments
- + 12.3» Display Audio with Navi
- + Seating - 7
- + AWD
- + 19» alloy wheels
- + Full TFT
- + Heads Up Display
- + Descent Control System

## TRIMS

### FABRIC

VISIA



### SYNTHETIC LEATHER BLACK

Applicable to Acenta and Acenta plus



## WHEELS

### 18" ALLOY

ACENTA



### 19" ALLOY

ACENTA PLUS



## COLOUR PALETTE

### 5 BASIC COLOURS



Glacier White - **QAK**



Pearl White - **QAB**



New Silver - **K23**



Gun Metallic Grey - **KAD**



Infinite Black - **G41**

### 5 COLOUR VARIATIONS



Sunset Orange - **EBL**



Caspian Blue - **RBY**



Scarlet Ember - **NBL**



Champagne Silver - **KAY**



Warrior Grey - **KBY**

### 5 TWO-TONE COMBINATIONS



Pearl White  
& Roof Black - **XBJ**



Caspian Blue  
& Roof Black - **XEU**



Sunset Orange  
& Roof Black - **XEV**



Champagne Silver  
& Roof Black - **XEW**



Warrior Grey  
& Roof Black - **XFU**

# ~~WE MAKE PROMISES.~~ WE KEEP PROMISES.

INTRODUCING NISSAN ASSURED, IT'S MORE THAN A PROMISE. AS PART OF THE NISSAN FAMILY YOU'RE GUARANTEED OUR COMMITMENT TO CUSTOMER CARE. A LASTING BOND BETWEEN YOU, YOUR VEHICLE AND THE NISSAN BRAND. **THAT'S OUR PROMISE.**

#### **CUSTOMER EXPERIENCE**

We promise to make your Nissan experience one to cherish, from your delivery day and everyday after, our commitment is to deliver a service experience you can trust – and believe in.

#### **CUSTOMER SUPPORT ROADSIDE ASSISTANCE**

We keep you on the road 24/7. Should anything unexpected happen we guarantee you 24-hour roadside assistance, no matter the age of your Nissan, because it's still a Nissan. Just call **0800 NISSAN (64 77 26)** anywhere, anytime. Terms and Conditions do apply.

#### **LICENCE RENEWAL REMINDER**

We'll remind you in advance so you can keep your licence disk up to date.

#### **3 YEAR OR 90 000KM SERVICE PLAN**

For the first 3 years or 90 000km of driving your car, whichever comes first, you can rest easy knowing that our promise to you is a kept one. We'll make sure your car is running smoothly and always on the road.

#### **6 YEAR OR 150 000KM WARRANTY**

As long as your car is under our warranty, we'll always have you covered if anything goes wrong. You don't need to stress for the first 6 years or 150 000km, whichever comes first.

#### **SERVICE AND REPAIRS FREE VEHICLE HEALTH CHECK**

We'll give your car a free health check on every major and minor service prior to any work being carried out, so you know exactly what needs to be done, and how much it will cost.

#### **COMPETITIVELY PRICED PARTS**

We deliver the highest care for your Nissan by fitting only Nissan Genuine Parts. The expertise of our Nissan trained teams will also guarantee best value-for-money by finding the most competitively priced part for your local dealer.

#### **COURTESY CAR**

We will arrange a courtesy car for all warranty repairs should the components required not be available within 48 hours.

**NISSAN** Assured  
More than a promise

Call **0800 NISSAN (64 77 26)**  
or visit [www.nissan.co.za](http://www.nissan.co.za) for more information.





Nissan Intelligent Mobility moves you one step ahead. In cars that feel like an extension of you, helping you see more and sense more, reacting with you, and sometimes even for you. Nissan Intelligent Mobility is about a better future – moving us to a world that’s safer, more sustainable, and exciting.

visit our website at: [www.nissan.co.za](http://www.nissan.co.za)