

---

# TOYOTA URBAN CRUISER



**GO FIND YOUR FUN**



Issued on: 2025/02/24



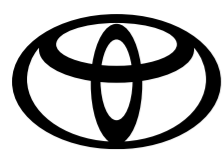

# SPECIFICATIONS

Urban Cruiser 1.5 Xs MT

Urban Cruiser 1.5 XR MT

Urban Cruiser 1.5 XR AT

| Engine and Drivetrain                       |                 |                 |                 |
|---|-----------------|-----------------|-----------------|
| Bore x Stroke (mm)                          | 74 x 85         | 74 x 85         | 74 x 85         |
| Displacement (cm <sup>3</sup> )             | 1462            | 1462            | 1462            |
| Emission Control                            | Euro 4 With OBD | Euro 4 With OBD | Euro 4 With OBD |
| Engine Code                                 | K15BN           | K15BN           | K15BN           |
| Fuel System                                 | Petrol          | Petrol          | Petrol          |
| Maximum Power (kW @ r/min)                  | 77@ @ 6000      | 77@ @ 6000      | 77@ @ 6000      |
| Maximum Torque (Nm @ r/min)                 | 138@ @ 4400     | 138@ @ 4400     | 138@ @ 4400     |
| Number of Cylinders and Arrangement         | Inline-4        | Inline-4        | Inline-4        |
| Engine capacity (litre)                     | 1.5             | 1.5             | 1.5             |
| Battery                                     | 38B20L          | 38B20L          | 38B20L          |
| Fuel Consumption (Combined Cycle) (l/100km) | 6.1             | 6.1             | 6.1             |
| CO2 Emission (g/km)                         | 146             | 146             | 144             |

| Transmission    |                |                |                   |
|-----------------|----------------|----------------|-------------------|
| Transmission    | Manual-5-speed | Manual-5-speed | Automatic-4-speed |
| Driven Wheels   | FWD            | FWD            | FWD               |
| Starting System | Push Start     | Push Start     | Push Start        |

| Suspension |                  |                  |                  |
|------------|------------------|------------------|------------------|
| Front      | MacPherson Strut | MacPherson Strut | MacPherson Strut |
| Rear       | Torsion-Beam     | Torsion-Beam     | Torsion-Beam     |

| Wheels and Tyres |  |  |  |
|------------------|--|--|--|
| Spare Wheel      | Full 215-60R17 Steel                   | Full 215-60R17 Steel                   | Full 215-60R17 Steel                   |
| Tyre Size        | F:215-60R17 Steel<br>R:215-60R17 Steel | F:215-60R17 Alloy<br>R:215-60R17 Alloy | F:215-60R17 Alloy<br>R:215-60R17 Alloy |

| Body and Styling         |  |   |   |
|--------------------------|--|---|---|
| Antenna                  | Standard Shark Fin                                 | Standard Shark Fin                                | Standard Shark Fin                                |
| Body Colour              | Monotone   | Two tone & Monotone                               | Two tone & Monotone                               |
| Daytime Running Light    | Standard LED                                       | Standard LED                                      | Standard LED                                      |
| Door Outside Handles     | Colour - Coded                                     | Colour - Coded                                    | Colour - Coded                                    |
| Front Bumper             | Colour Coded                                       | Colour Coded                                      | Colour Coded                                      |
| Grade Mark               | Standard XS  | Standard XR                                       | Standard XR                                       |
| Headlights               | Bi-Halogen   | Bi-Halogen  | Bi-Halogen  |
| Headlamp Levelling       | Standard Manual                                    | Standard Manual                                   | Standard Manual                                   |
| High-Mounted Brake Light | Standard LED                                       | Standard LED                                      | Standard LED                                      |
| Side Mirrors             | Colour Coded With Indicator /<br>Power Retractable | Roof Colour With Indicator /<br>Power Retractable | Roof Colour With Indicator /<br>Power Retractable |
| Front Grille             | Black, Chrome                                      | Black, Chrome                                     | Black, Chrome                                     |
| Rear Bumper              | Colour Coded                                       | Colour Coded                                      | Colour Coded                                      |

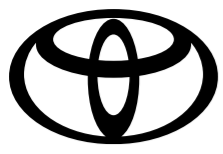

# SPECIFICATIONS

Urban Cruiser 1.5 Xs MT

Urban Cruiser 1.5 XR MT

Urban Cruiser 1.5 XR AT

## Body and Styling

|                    |                       |                       |                       |
|--------------------|-----------------------|-----------------------|-----------------------|
| Rear Lights        | LED                   | LED                   | LED                   |
| Front Window Wiper | •                     | •                     | •                     |
| Front Fog Lamps    |                       |                       |                       |
| Rear Spoiler       | Standard Roof Spoiler | Standard Roof Spoiler | Standard Roof Spoiler |
| Roof Rails         |                       | Standard Black        | Standard Black        |

## Interior, Comfort and Convenience

|                            |                               |                               |                               |
|----------------------------|-------------------------------|-------------------------------|-------------------------------|
| Assist Grip                | Standard 3                    | Standard 3                    | Standard 3                    |
| Coat Hook                  | Standard 1                    | Standard 1                    | Standard 1                    |
| Cupholders                 | Standard 4                    | Standard 4                    | Standard 4                    |
| Door Inside Handles        | Chrome                        | Chrome                        | Chrome                        |
| Door Trim                  | Paint                         | Paint                         | Paint                         |
| Floor Carpet Trim          | Carpet                        | Carpet                        | Carpet                        |
| Front Headrest             | Adjustable                    | Adjustable                    | Adjustable                    |
| Instrument Panel Trim      | Black                         | Black                         | Black                         |
| Rear View Mirror           | Day & Night                   | Day & Night                   | Day & Night                   |
| Key Reminder Warning       | •                             | •                             | •                             |
| Meter Illumination Control | •                             | •                             | •                             |
| Rear Headrests             | Adjustable 3                  | Adjustable 3                  | Adjustable 3                  |
| 2nd Row Seats              | 60:40 Manual                  | 60:40 Manual                  | 60:40 Manual                  |
| Seat Trim                  | Fabric                        | Fabric                        | Fabric                        |
| Shift Lever & Knob         | Urethane                      | Urethane                      | Urethane                      |
| Speedometer                | Analog Tachometer             | Analog Tachometer             | Analog Tachometer             |
| Steering Wheel             | 3 Spoke Urethane              | 3 Spoke Urethane              | 3 Spoke Urethane              |
| Seat Back Pockets          | Standard Driver and Passenger | Standard Driver and Passenger | Standard Driver and Passenger |
| Front Personal Lamp        | •                             | •                             | •                             |
| Console trim               | PVC                           | PVC                           | PVC                           |
| Centre Console             | Standard Front                | Standard Front                | Standard Front                |
| Luggage Tray               | •                             | •                             | •                             |
| Cruise Control             |                               | •                             | •                             |
| Airconditioner             | Auto                          | Auto                          | Auto                          |
| Audio System               | Toyota Display Audio          | Toyota Display Audio          | Toyota Display Audio          |
| Auxiliary Input            | •                             | •                             | •                             |

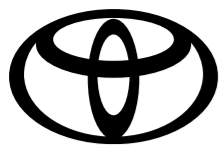

# SPECIFICATIONS

Urban Cruiser 1.5 Xs MT

Urban Cruiser 1.5 XR MT

Urban Cruiser 1.5 XR AT

## Interior, Comfort and Convenience

|                              |   |   |   |
|------------------------------|---|---|---|
| Reverse Camera               | Display Audio   | Display Audio   | Display Audio   |
| Bluetooth                    | •   | •   | •   |
| Door Ajar Warning            | •   | •   | •   |
| Footrest                     | •   | •   | •   |
| Front Armrest                | Standard With Slide   | Standard With Slide   | Standard With Slide   |
| Front Seat Vertical Adjuster | Driver Manual   | Driver Manual   | Driver Manual   |
| Light Remind Warning         | Standard Buzzer   | Standard Buzzer   | Standard Buzzer   |
| Heater                       | Manual  | Manual  | Manual  |
| Multi-Information Display    | Standard-TFT-Colour   | Standard-TFT-Colour   | Standard-TFT-Colour   |
| Power Socket                 | Front - 12V   | Front - 12V   | Front - 12V   |
| Power Steering               | Electric / (EPS)  | Electric / (EPS)  | Electric / (EPS)  |
| Electric Windows             | All One Touch Driver only   | All One Touch Driver only   | All One Touch Driver only   |
| Rear Airconditioner          | •   | •   | •   |
| Rear Armrest                 | Standard 2 Cupholders   | Standard 2 Cupholders   | Standard 2 Cupholders   |
| Speakers                     | Standard 2  | Standard 4  | Standard 4  |
| Steering Column Adjustments  | Manual Tilt & Telescopic  | Manual Tilt & Telescopic  | Manual Tilt & Telescopic  |
| Steering Switches            | Standard Audio  | Standard Audio, Telephone, Cruise Control   | Standard Audio, Telephone, Cruise Control   |
| Sun Visor                    | Standard Mirror with Cover, Ticket Holder Driver + Passenger, Passenger Mirror with Cover | Standard Mirror with Cover, Ticket Holder Driver + Passenger, Passenger Mirror with Cover | Standard Mirror with Cover, Ticket Holder Driver + Passenger, Passenger Mirror with Cover |
| USB                          | •   | •   | •   |
| Android Auto & Apple CarPlay | •   | •   | •   |
| Toyota Connect Enabled       | •   | •   | •   |

## Safety and Security

|                                 |                             |                             |                             |
|---------------------------------|-----------------------------|-----------------------------|-----------------------------|
| Anti-Theft System               | Immobiliser Alarm           | Immobiliser Alarm           | Immobiliser Alarm           |
| Centre Rear Seatbelt            | Standard 3-Point            | Standard 3-Point            | Standard 3-Point            |
| Child Lock                      | Standard Rear door          | Standard Rear door          | Standard Rear door          |
| Child Restraint System (ISOFIX) | Standard 2                  | Standard 2                  | Standard 2                  |
| Parking Brake                   | Lever                       | Lever                       | Lever                       |
| Front Brake                     | Ventilated Disc             | Ventilated Disc             | Ventilated Disc             |
| Front Seat Belts                | Pretensioner, Force Limiter | Pretensioner, Force Limiter | Pretensioner, Force Limiter |
| Power Door Lock                 | Standard                    | Standard                    | Standard                    |
| Rear Brake                      | Disc                        | Disc                        | Disc                        |
| Rear Seat Belts                 | Standard ELR                | Standard ELR                | Standard ELR                |

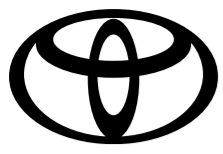

# SPECIFICATIONS

Urban Cruiser 1.5 Xs MT

Urban Cruiser 1.5 XR MT

Urban Cruiser 1.5 XR AT

## Safety and Security

|                    |  |  |  |
|--------------------|--|--|--|
| Seat Belt Warning  | Front D: Light, D: Buzzer, P: Light, P: Buzzer | Front D: Light, D: Buzzer, P: Light, P: Buzzer | Front D: Light, D: Buzzer, P: Light, P: Buzzer |
| Wireless Door Lock | Standard Smart Entry                           | Standard Smart Entry                           | Standard Smart Entry                           |
| Airbags            | Driver, Passenger                              | Side, Curtain, Driver, Passenger               | Side, Curtain, Driver, Passenger               |

## Driver Support Systems

|   |               |               |               |
|---|---------------|---------------|---------------|
| Park Distance Control                     | Standard Rear | Standard Rear | Standard Rear |
| Anti-Lock Braking System (ABS)            | •             | •             | •             |
| Electronic Brake Force Distribution (EBD) | •             | •             | •             |
| Hill Assist Control (HAC)                 | •             | •             | •             |
| Vehicle Stability Control (VSC)           | •             | •             | •             |

## Service and Warranty

|                  |                       |                       |                       |
|------------------|-----------------------|-----------------------|-----------------------|
| Service Plan     | 4 Services / 60,000km | 4 Services / 60,000km | 4 Services / 60,000km |
| Service Interval | 12 months / 15,000km  | 12 months / 15,000km  | 12 months / 15,000km  |
| Warranty         | 3 years / 100,000km   | 3 years / 100,000km   | 3 years / 100,000km   |

## Dimensions and Capacities

|                                 |           |           |           |
|---------------------------------|-----------|-----------|-----------|
| Front Overhang (mm)             | 915       | 915       | 915       |
| Front Tread (mm)                | 1530      | 1530      | 1530      |
| Fuel Tank Size (L)              | 45        | 45        | 45        |
| Gross Combination Mass (GCM)    | 2810      | 2810      | 2820      |
| Ground Clearance (mm)           | 210       | 210       | 210       |
| Gross Vehicle Mass (GVM)        | 1610      | 1610      | 1620      |
| Height (mm)                     | 1635      | 1635      | 1635      |
| Kerb Weight (kg)                | 1130-1165 | 1130-1165 | 1130-1165 |
| Length (mm)                     | 4365      | 4365      | 4365      |
| Luggage Capacity (L)            | 353       | 353       | 353       |
| Rear Overhang (mm)              | 830       | 830       | 830       |
| Rear Tread (mm)                 | 1535      | 1535      | 1535      |
| Towing Capacity - Unbraked (kg) | 400       | 400       | 400       |
| Towing Capacity - Braked (kg)   | 1200      | 1200      | 1200      |
| Turning circle (tyres, m)       | 5.4       | 5.4       | 5.4       |
| Wheelbase (mm)                  | 2600      | 2600      | 2600      |
| Width (mm)                      | 1795      | 1795      | 1795      |
| Top Speed (km/h)                | 170       | 170       | 165       |

**LINE DRAWING**

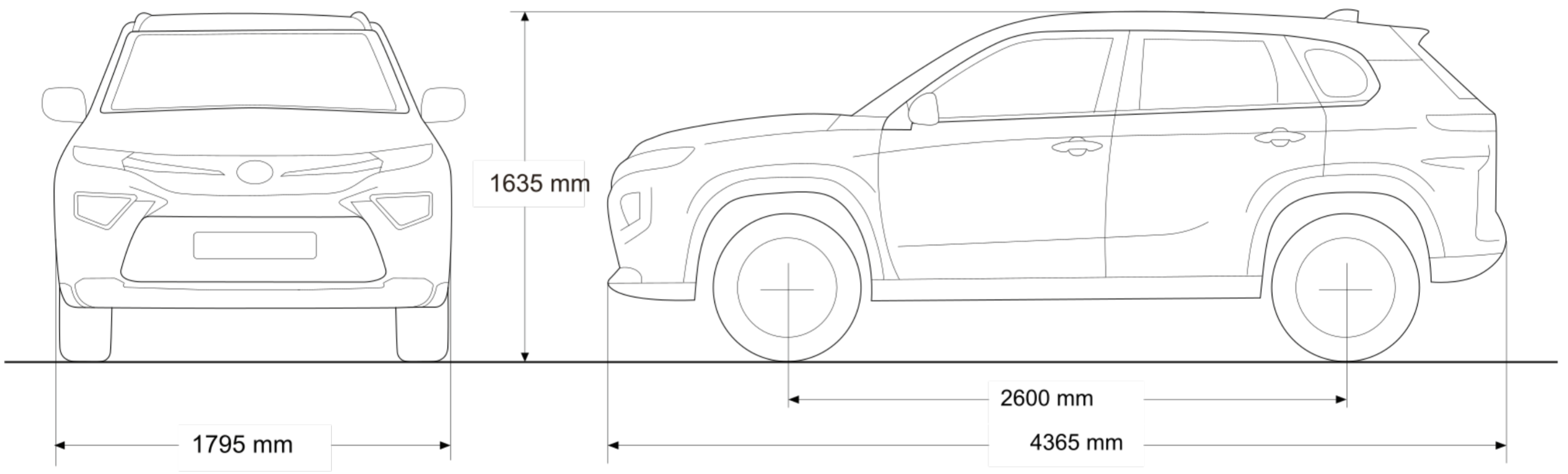

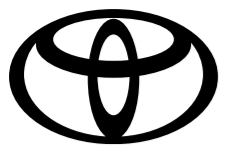

# SPECIFICATIONS

## EXTERIOR COLOURS

FOR ILLUSTRATIVE PURPOSES ONLY.

### MONOTONE



ZHJ - Mystic Pearl White



WBE - Premium Liquid Silver



WBF - Shadow Grey



WAJ - Jet Blue



WBG - Luxe Red



ZAM - Shadow Black Pearl



ZQD - Smoke Black Pearl

### BI-TONE

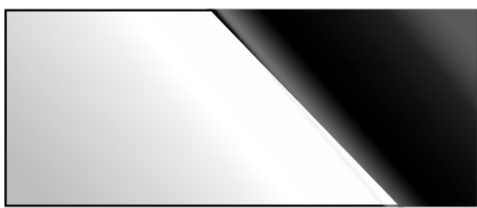

C9J - Mystic Pearl White Bi-Tone



ERD - Liquid Silver Bi-Tone



ESY - Jet Blue Bi-Tone



ESL - Luxe Red Bi-Tone

**Disclaimer:**

The information contained within or made available on any Toyota platform or note including but not limited to, this website/brochure/specification sheet, is provided for information purposes only. While we make reasonable efforts to update the information on our platform/s, Toyota Motor Corporation of Japan, and Toyota South Africa Motors (Pty) Ltd makes no representations, warranties, or guarantees, whether express or implied, that the content is accurate, complete or up to date, and all information contained herein is subject to change without notice.

Vehicle specifications may vary depending on the model, trim level, and market. Colours depicted on print and web material may not match the actual vehicle colour. Fuel consumption figures are estimates based on standardised testing conditions and actual results may vary due to (but not limited to) driving style, vehicle loading, tyres, wind, traffic, and accessories. All dimensions, capacities, and performance figures are approximate. Some features/options may be optional or only available on certain models/trim levels. Images and illustrations are for illustrative purposes only and may not reflect the actual vehicle.

Your use of, or reliance on, any information or contents herein is entirely at your own risk. Toyota Motor Corporation of Japan and Toyota South Africa Motors (Pty) Ltd (including its owners, agents, consultants, employees, and any affiliated person(s)) are not responsible for any loss or damages related to your use of, reliance on, or understanding of any information or contents on this or any other Toyota platform. This includes, without limitation, any direct, indirect, special, incidental, consequential, or punitive damages in terms of any contract, delict (breach of a duty of care) or law.

Furthermore, Toyota Motor Corporation of Japan and Toyota South Africa Motors (Pty) Ltd do not guarantee the uninterrupted or error-free operation of any platform or the availability of content, and are not liable for any interruptions, errors, or damages caused by any technical issues or limitations of these platforms, including but not limited to, server downtime, software malfunctions, or internet connectivity issues.



